

THETFORD

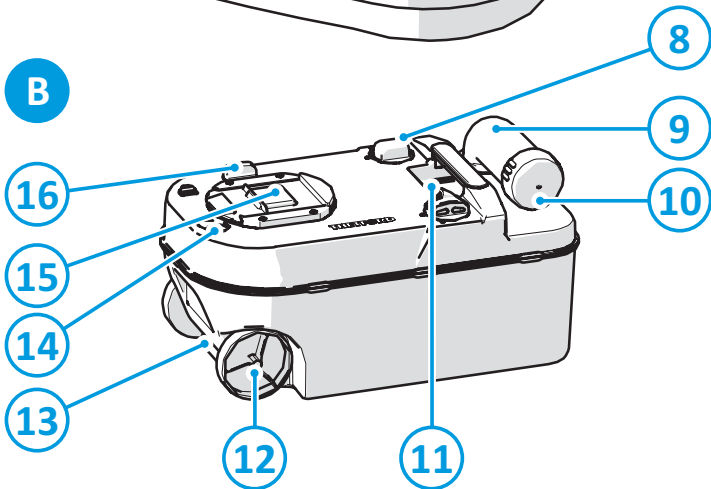

Cassette Toilet C220 Series

User Manual

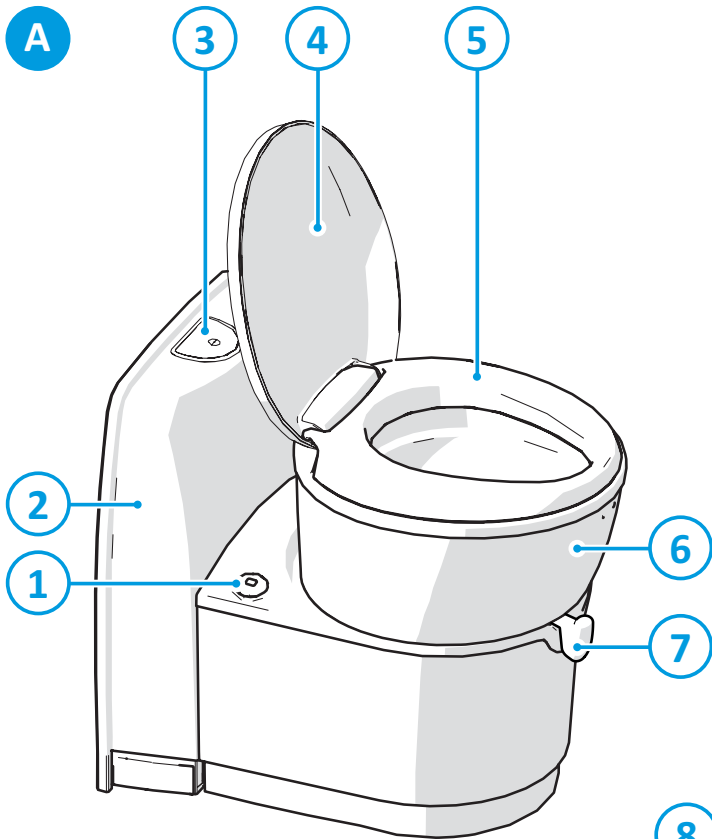

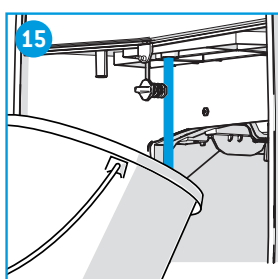
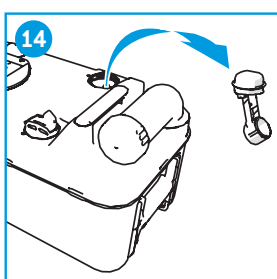
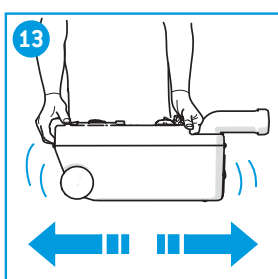
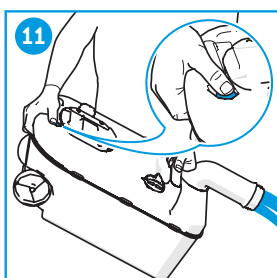
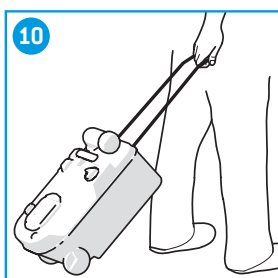
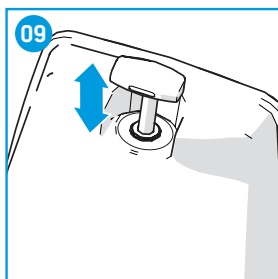
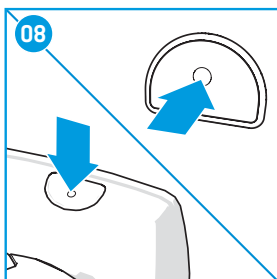
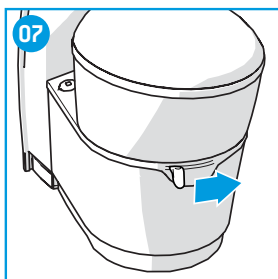
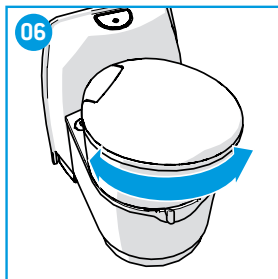
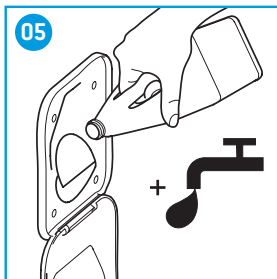
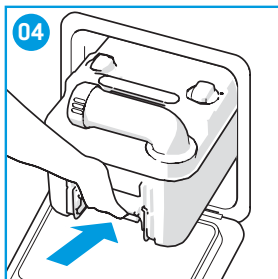
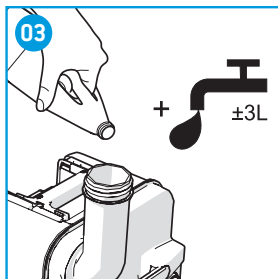
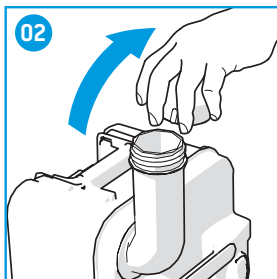
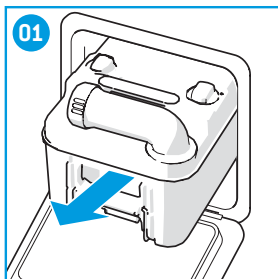

TAKE CARE, TAKE THETFORD

World's best selling toilet additives



We: THETFORD B.V.

Address: Nijverheidsweg 29, 4879 AP, Etten-Leur, Netherlands
Telephone: +31 76 5042 200 Fax: +31 76 5042 300

Declare that

Product Types; Cassette toilet

Model Number/Description; C220 Series

Satisfies the essential requirements of the following directives:

- 2011/65/EU RoHS 2

- Automotive EMC Directive 2004/104/EC

Based on the following standards applied:

- EN 50498:2010 EMC aftermarket Electronic equipment in vehicles

The products concerned have no immunity related functions in accordance with the Automotive EMC Directive 2004/104/EC

Name : S.P. Cordeille
Title/Position : Chief Executive Officer
Place & Date of Issue : Etten-Leur, 12 February 2016

Signature

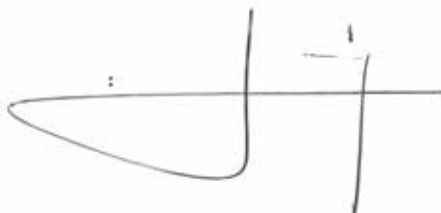

EN

Original User Manual

Contents

1	Introduction.....	2
2	Symbols.....	2
3	Main components.....	3
4	Before use.....	3
5	Use of the toilet.....	4
6	Emptying the waste-holding tank.....	5
7	Emptying the flush-water tank (C224-CW/C222-SWE).....	5
8	Maintenance and cleaning.....	6
9	Winter use.....	6
10	Troubleshooting.....	6
11	Servicing.....	7
12	Putting in storage.....	7
13	Questions.....	7
14	Warranty.....	7

1. Introduction

This is the user manual for your Thetford toilet. Read the safety instructions and information on use and maintenance of the toilet carefully before continuing. This will enable you to use the toilet safely and efficiently. Retain this manual for future reference.

For the latest version of this manual, please visit www.thetford.com.

2. Symbols

Key to symbols:



Warning. Risk of serious injury and/or damage.



Caution. Risk of injury and/or damage.



Attention. Important information.



Note. Information.

3. Main components

See the image in the fold-out cover for a visual reference.

- | | | |
|-----------------------------|---|-------------------------------------|
| A. Toilet | 1. Level indication | 9. Pour out spout |
| B. Waste-holding tank (18L) | 2. Console (C223-CS)
Flush-water tank (C224-CW/C222-SWE) | 10. Cap |
| | 3. Control panel* | 11. Automatic pressure release vent |
| | 4. Cover | 12. Wheel |
| | 5. Seat | 13. Pull handle |
| | 6. Swivelling toilet bowl | 14. Vent button |
| | 7. Blade handle | 15. Sliding cover |
| | 8. Float | 16. Blade opener |

*The image shows the C223-CS, which features a flush button on the control panel on the console to flush the toilet.



The C223-S/C223-CS uses the central water tank of the vehicle to flush. The C224-CW/C222-SWE have a flush-water tank.



The C224-CW features a flush handle on the console to flush the toilet. The C223-S and C222-SWE feature a flush button on the control panel on the wall to flush the toilet.



A cassette toilet is not connected to a central sewage. This toilet has an integrated sewage system (B), which you need to empty when full.

4. Before use

See the images in the fold-out cover for a visual reference.

- Ensure that all packaging materials have been removed.

Prepare the waste-holding tank:

- Remove the waste-holding tank through the service door (01).
- Place the waste-holding tank upright and turn the pour out spout upwards.
- Remove the cap from the pour out spout (02).
- Check the correct dosage of Thetford waste-holding tank additive on the package.
- Add the stated dosage to the waste-holding tank (03).
- Add $\pm 3\text{L}$ of water to the waste-holding tank to ensure that the bottom of the waste-holding tank is covered (03).
- Screw the cap back onto the pour out spout.
- Slide the waste-holding tank back into its original position via the service door (04).

Prepare the flush-water tank (only for C224-CW and C222-SWE):

- Check the correct dosage of Thetford flush-water tank additive on the package.
- Add the stated dosage to the flush-water tank through the waterfill door (05).
- Fill the flush-water tank with clean water through the waterfill door, using a jerry can or hose (05).



Not using Thetford products to care for your Thetford toilet could cause damage.



Never add toilet additives directly via the valve blade or via the toilet bowl as this could damage the lip seal of the waste-holding tank. Only fill the waste-holding tank via the pour out spout.



Never use force if you cannot get the waste-holding tank back into place easily. If blockage occurs, always check if the blade handle is in the closed position.

Check after storage:

- After storage, check the water installation on damages before filling the system with water again.
- After filling the system, check if flush is present and make sure there are no leakages.

5. Use of the toilet



The toilet can withstand a maximum load of 120kg. Make sure you do not overload the toilet.

See the images in the fold-out cover for a visual reference.

Turning the toilet bowl:

- Close the cover and use both hands to rotate the bowl to the desired position (max. 90° clockwise and 170° counterclockwise) [06].

Opening the blade:

- Open the blade by moving the blade handle from left to right [07].
- Always close the blade completely after use.



The toilet can be used with the blade open or closed.

Flushing the toilet:

- Make sure the blade is open.

For C223-S/C223-CS/C222-SWE:

- Press the flush button and hold it for several seconds to flush the toilet [08].

For C224-CW:

- Move the flush handle up and down to flush the toilet [09].
- Close the blade after flushing.



Ordinary toilet paper can cause clogging. Use Thetford Aqua Soft toilet paper for your toilet. This toilet paper is super-soft, dissolves quickly, prevents clogging and makes it easier to empty the waste-holding tank.



For C223-S/C223-CS/C222-SWE: The flush of your toilet will be more effective if you pulsate the flush by pressing the flush button several times in a row.



To prevent water damage to your caravan or motor home, do not travel with water in the toilet bowl.



Do not leave water in the toilet bowl if the toilet is not being used. This does not help to reduce unpleasant smells and only leads to flooding.

6. Emptying the waste-holding tank

See the images in the fold-out cover for a visual reference.

Your toilet has a 1-level indication for the waste-holding tank. When the slide turns from green to red, the waste-holding tank is full.

Emptying the waste-holding tank:

- Remove the waste-holding tank [01].
- Fold out the pull handle until it is fully extended.
- Pull the tank to an authorised waste disposal point [10].
- Place the waste-holding tank upright and turn the pour out spout upwards.
- Remove the cap from the pour out spout [02].
- Press and hold the vent button with your thumb while the pour out spout is pointing downwards to empty the waste-holding tank [11].
- Add ±5L of water to the waste-holding tank and replace the cap [12].
- Gently shake the tank to clean it [13]. Empty the waste-holding tank again [11].
- Remove the float from the waste-holding tank by turning it clockwise and rinse the float with tap water [14].
- Fold in the pull handle until it clicks into place.
- Slide the waste-holding tank into the toilet and close the service door [04].
- If you want to continue using your toilet after emptying the waste-holding tank, prepare the waste-holding tank again. See Before use.



To prevent water damage to your caravan or motor home, do not travel with a waste-holding tank that is more than 3/4 full. This may cause leakage through the venting system.



Do not allow the waste-holding tank to become too full.



Thetford green toilet additives are completely safe to empty into a septic tank or small biological systems on camping sites.

7. Emptying the flush-water tank (C224-CW/C222-SWE)

See the images in the fold-out cover for a visual reference.

Only empty the flush-water tank completely if you expect not to use your toilet for a long period.

Emptying the flush-water tank:

- Place a sufficiently large bowl under the drain tube.
- Open the drain tube and catch the remaining water in the bowl [15].
- Empty the bowl at an authorised waste disposal point.



To prevent water damage to your caravan or motor home, do not travel with a flush-water tank that is too full. Thetford advises travelling with an empty flush-water tank, but at least not filled more than half-full.

8. Maintenance and cleaning

See the images in the fold-out cover for a visual reference. Also see the inside cover for an overview of the additives which need to be used.

Thetford recommends cleaning your toilet regularly to prevent limescale and ensure optimal hygiene.

- Clean the inside of the bowl with Thetford Toilet Bowl Cleaner and a soft brush.
- Clean the outside of the bowl with Thetford Bathroom Cleaner.
- Remove the seat and cover to clean your toilet thoroughly. To do this, push the seat and cover together to the right, then lift them up.
- Remove the float from the waste-holding tank and rinse it with tap water [04].



Never use household cleaners to clean your toilet. These may cause permanent damage to the seals and other toilet components. For example, the use of liquid bleach could lead to discoloration.

Thetford recommends maintaining your toilet regularly to prolong the lifespan of your toilet.

- Use Thetford Cassette Tank Cleaner 2 to 3 times a year on the waste-holding tank to remove stubborn limescale on the inside of the tank.
- Use Thetford Seal Lubricant to keep the seals soft and pliable. It has been specially developed for mobile toilets and is absolutely safe to use.



Never use Vaseline or vegetable oil to lubricate the seals. This may cause leakage to your waste-holding tank.



The blade seal is a part of the toilet that is subject to wear. Depending on the extent and manner of servicing, after a certain period the seal will lose quality and must be replaced.

9. Winter use

You can use your toilet as normal in cold weather as long as the toilet is situated in a heated location. If this is not the case, and there is a risk of frost, we advise not to use your toilet. Make sure you completely drain the toilet and the water system of the vehicle. Then empty the waste-holding tank and the flush-water tank (if applicable), see Putting in storage.

10. Troubleshooting

Problem	Possible cause	Solution
Waste-holding tank cannot be removed	Blade is (partly) open	Fully close the blade
Blade does not move	Blade is blocked	Loosen cap from pour out spout
Level indication waste-holding tank does not work	Mechanism level indication in waste-holding tank is stuck	Remove mechanism from waste-holding tank and rinse it with tap water

Problem	Possible cause	Solution
Waste-holding tank leaks	Seal is dry Seal is worn	Spray seal with seal lubricant Replace seal



If you cannot solve a problem, contact the authorised local Service Centre or Thetford Customer Service in your country.

11. Servicing

EN

All servicing must be carried out by an approved competent person.

For service, please contact your authorised local Service Centre giving details of the model and serial number on the data badge plus date of purchase.

The data badge can be found on the base of the toilet.



12. Putting in storage

- Empty the flush-water tank (dependent on model) and the water system of the vehicle.
- Push the flush button until no flush-water is visible.
- Empty the waste-holding tank.
- Thoroughly clean and dry the whole toilet.
- Open the blade and loosen the cap of the pour out spout to ventilate the waste-holding tank.
- We recommend maintaining your toilet before putting it into storage. Refer to Maintenance and cleaning.

13. Questions

If you have questions about your product, parts, accessories or authorised services:

- Visit www.thetford.com.
- If you cannot solve a problem, contact the authorised local Service Centre or Thetford Customer Service in your country.

14. Warranty

For our warranty clause, please refer to the conditions mentioned on www.thetford-europe.com/service/warranty. For more information, please contact the Thetford Customer Service in your country.

EUROPEAN HEADQUARTERS

Thetford B.V.
Nijverheidsweg 29
P.O. Box 169
4870 AD Etten-Leur
The Netherlands

T +31 76 504 22 00
F +31 76 504 23 00
E info@thetford.eu

UNITED KINGDOM

Thetford Ltd.
Unit 6
Brookfields Way
Manvers, Rotherham
S63 5DL, England
United Kingdom

T +44 844 997 1960
F +44 844 997 1961
E info@thetford.eu

GERMANY

Thetford GmbH
Schallbruch 14
D-42781 Haan
Deutschland

T +49 2129 94250
F +49 2129 942525
E info@thetford.eu

FRANCE

Thetford S.A.R.L.
Parc BUROPLUS / Bâtiment 6
18, Boulevard de la Paix
95800 CERGY
France

T +33 1 30 37 58 23
F +33 1 30 37 97 67
E info@thetford.eu

ITALY

Thetford Italy c/o Tecma s.r.l.
Via Flaminia
Loc. Castel delle Formiche
05030 Otricoli (TR)
Italia

T +39 0744 709071
F +39 0744 719833
E info@thetford.eu

SPAIN AND PORTUGAL

Mercè Grau Solà
Agente para España y Portugal
c/ Castellet, 36 bxs 2º
08800 Vilanova i la Geltrú
Barcelona
España

T +34 938 154 389
F not available
E info@thetford.eu

SCANDINAVIA

Thetford B.V.
Representative Office Scandinavia
Hantverkaregatan 32D
521 61 Stenstorp
Sverige

T +46 31 336 35 80
F +46 31 44 85 70
E info@thetford.eu

AUSTRALIA

Thetford Australia Pty. Ltd.
41 Lara Way
Campbellfield VIC 3061
Australia

T +61 3 9358 0700
F +61 3 9357 7060
E info@thetford.eu
www.thetford.com.au

CHINA

Thetford China
Rm. 1207, Coastal Building
(East Block)
Haide 3rd Road, Nanshan District
Shenzen, 518054
China

T +86 755 8627 1393
F +86 755 8627 1673
E info@thetford.cn
www.thetford.cn