

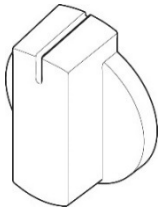

LE1326_SCK12XXX_1216-V01

		Spare part number	Spare part number	Colours available	
1	Glass lid (BK : smoke black)	SSPA0230		.BK	
	Glass lid (SBK : solid black)	SSPA0231		.SBK	
2	Glass lid hinges 2x	SSPA0010			
3	Pan support	SSPA0963			
4	Pan support clips 4x	SSPA0041			
	Pan support clips 50x	SSPA0042			
5	Burner assy (medium)				
	Production date: < 17-10-2011 (< E290M.....)	SSPA0112			
	Production date: ≥ 18-10-2011 (≥ E291M.....)	SSPA0116			
6	Burner assy (small)				
	Production date: < 17-10-2011 (< E290M.....)	SSPA0102			
	Production date: ≥ 18-10-2011 (≥ E291M.....)	SSPA0811			
7	Burner assy (medium lower rated)				
	Production date: < 17-10-2011 (< E290M.....)	SSPA0114			
	Production date: ≥ 18-10-2011 (≥ E291M.....)	SSPA0812			
8	Spark electrode 4x				
	Production date: < 17-10-2011 (< E290M.....)	SSPA0310			
	Production date: ≥ 18-10-2011 (≥ E291M.....)	SSPA0320			
9	Thermocouples hob				
	Production date: < 17-10-2011 (< E290M.....)		For lid shut off		
	Front left	SSPA0675	SSPA0673		
	Front right	SSPA0675	SSPA0673		
	Rear Left	SSPA0676	SSPA0673		
	Rear Right	SSPA0676	SSPA0672		
	Production date: ≥ 18-10-2011 (≥ E291M.....)		For lid shut off		
	Front left	SSPA0680	SSPA0686		
	Front right	SSPA0681	SSPA0685		
	Rear Left	SSPA0682	SSPA0689		
	Rear Right	SSPA0682	SSPA0684		
	10	Bump stops 2x	SSPA0040		
	11	Gas tap oven			
		Production date: < 17-10-2011 (< E290M.....)	SSPA0452		
Production date: ≥ 18-10-2011 (≥ E291M.....)		SSPA0450			
12	Gas tap grill				
	Production date: < 17-10-2011 (< E290M.....)	SSPA0472			
	Production date: ≥ 18-10-2011 (≥ E291M.....)	SSPA0430			
13	Gas tap burner 1x				
	Production date: < 17-10-2011 (< E290M.....)	SSPA0432			
	Production date: ≥ 18-10-2011 (≥ E291M.....)	SSPA0470			
14	Spark ignition button (=incl. switch)	SSPA0380			
15	Cut out thermal *1x NO and 1x NC	SSPA0510			
16	Control knobs	<i>Refer to page 4</i>			
17	Grill door	<i>Refer to page 4</i>			
18	Oven door	<i>Refer to page 5</i>			
19	Lower door *only for 3/4 height	<i>Refer to page 6</i>			

		Spare part number	Spare part number	Colours available
20	Glass, inner door	SSPA0253		
21	Oven door seal	SSPA0062		
22	Oven shelf x1	SSPA0980		
23	Grill pan	SSPA0991		
24	Spark generator	SSPA0301		
25	Oven burner			
	Production date: < 31-07-21 (E212Y...)	SSPA0191		
	Production date: ≥ 01-08-21 (E213Y...)	SSPA0198		
26	Thermocouple oven	SSPA0622	SSPA0623	
		< 17-10-2011	≥ 17-10-2011	
27	Electrode oven	(< E290M.....)	(E290M.....)	
28	Grill Burner			
	Production date: < 05-05-2015 (E125S.....)	Not available		
	Production date: ≥ 06-05-2015 (E126S.....)	SSPA0185		
29	Thermocouple grill			
30	Electrode grill	<i>Refer to page 6</i>		
31	Cooling fan kit	SSPA0521		
32	Grill shut off	SSPA0605		



Control knobs

Control Knob sets		
Spare part number	SSPA0901	SSPA0904
Colours available	Gloss Nickel (.GNK)	Matt Nickel (.MNK)
Set quantity	6	6

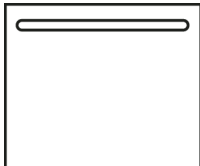
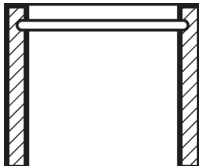
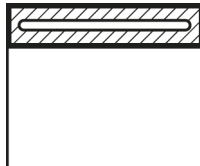
Cladding styles

No cladding	Side cladding	Behind handle cladding
		

Grill Doors

Spare part number	Glass	Print	Cladding	Cladding Position	Handle Style	Handle Colour
SMAO4120.BK1X	Clear	Black	Yes	Sides		Steel
SMAO4120.BK7X	Clear	Black	No	N/A		Chrome
SMAO4120.BKX	Clear	Black	Yes	Sides		Brushed Nickel

Oven door styles

Drop down oven doors

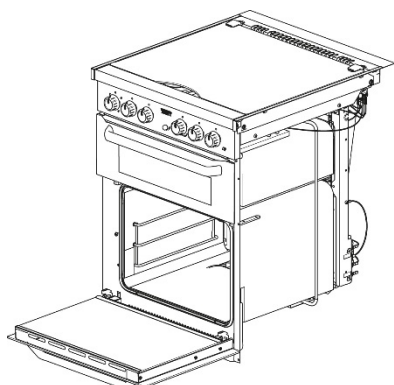

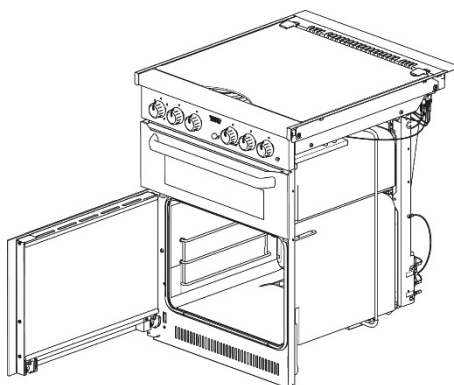

Left hinged oven doors



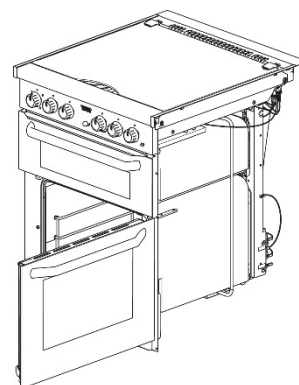

Right hinged oven doors



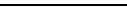

Drop down oven doors

Spare part number	Glass	Print	Cladding	Cladding Position	Handle Style	Handle Colour
SMAO4130.BKX	Clear	Black	Yes	Sides		Brushed Nickel
SMAO4130.BK1X	Clear	Black	Yes	Sides		Silver
SMAO4130.BK7X	Clear	Black	No	N/A		Chrome

Left hinged oven doors

Spare part number	Glass	Print	Cladding	Cladding Position	Handle Style	Handle Colour
SMAO4135.BK3LX	Clear	Black	Yes	Top		Satin
SMAO4135.BK7LX	Clear	Black	No	N/A		Chrome

Right hinged oven doors

Spare part number	Glass	Print	Cladding	Cladding Position	Handle Style	Handle Colour
SMAO4135.BK3RX	Clear	Black	Yes	Top		Satin
SMAO4135.BK7RX	Clear	Black	No	N/A		Chrome

Lower doors

Spare part number	Glass	Print	Cladding	Cladding Position	Handle Style	Handle Colour
SMAO4160.BKX	Clear	Black	No	N/A	N/A	N/A
SMAO4160.BK1X	Clear	Black	Yes	Sides	N/A	N/A
SMAO4161.BKX	Clear	Black	No	N/A	N/A	N/A

Thermocouple grill and Electrode grill

Production date	Spare part number
14-07-2008 (E195H.....) to 17-10-2011 (E290M.....)	SSPA0624
18-10-2011 (E291M.....) to 05-09-2012 (E129N.....)	SSPA0630
06-09-2012 (E130N.....) to 26-04-2015 (E116S.....)	SSPA0625
27-04-2015 (E117S.....) to present	SSPA0631